

AFH ATC Die C0708 (V 6)

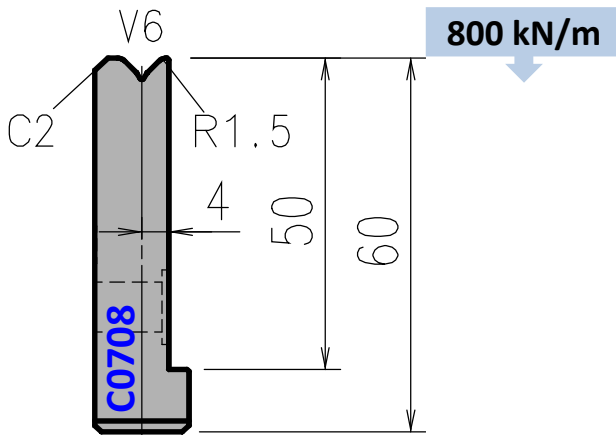

Tool angle	Length mm	Item No.	Weight Kg
86°	200 Div.	C0708155	4,2
	Short Div.	C0708156	2,6