

# AFH ATC Die C0743 (V 12)

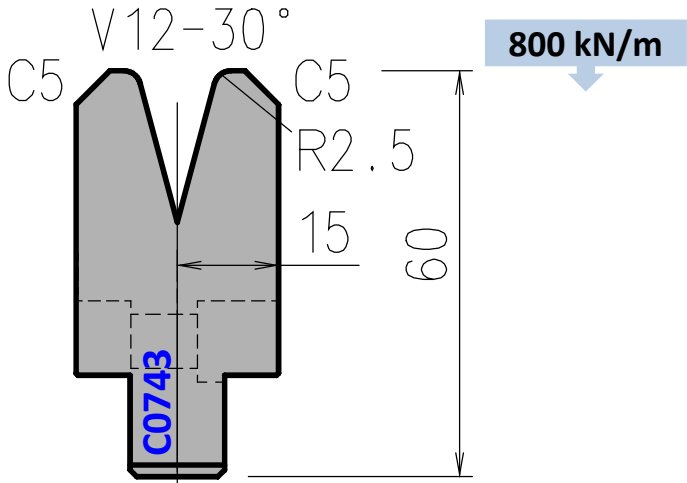

Tool angle	Length mm	Item No.	Weight Kg
30°	200 Div.	C0743255	8,7
	Short Div.	C0743256	5,2