

Large V160 Die 80°

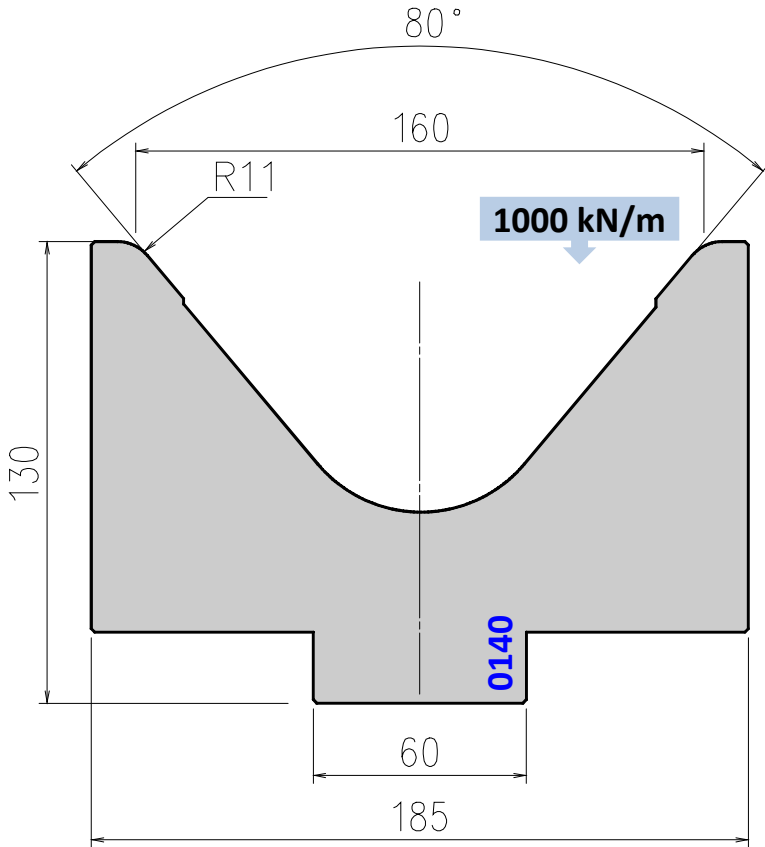

Hardness: 52-56 HRC; inductionhard.; Depth: 2mm

Die 014011 replaces old die Z0160

Tool angle	Length mm	Item No.	Weight Kg
80°	835	ED0140111	92,6
	415	ED0140112	46,0