

# Large V32 Die 45°

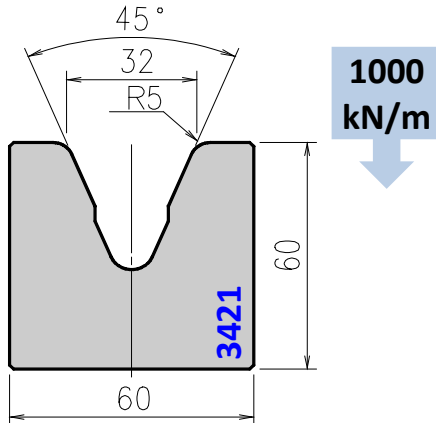

Die 342150 replaces old die 34200

Tool angle	Length mm	Item No.	Weight Kg
45°	835	ED3421501	19,3
	415	ED3421502	9,6
	800 sect.	ED3421503	18,5