

Large V50 Die 85°

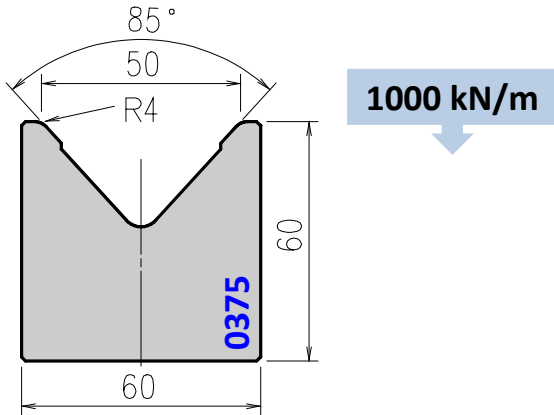

Die 037540 replaces old die 03700

Tool angle	Length mm	Item No.	Weight Kg
85°	835	ED0375401	18,7
	415	ED0375402	9,3
	800 sect.	ED0375403	17,9