

2V Reversible Die (V6x10-60°)

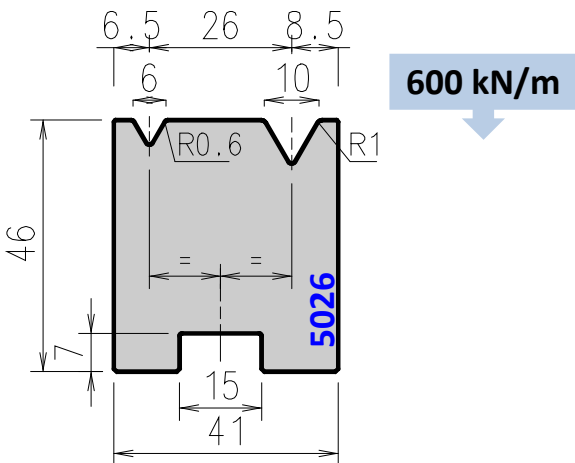

Die 502606 replaces old die 50260

Tool angle	Length mm	Item No.	Weight Kg
60°	835	ED5026061	11,3
	415	ED5026062	5,6
	800 sect.	ED5026063	10,8