

2V Reversible Die (V6x10-88°)

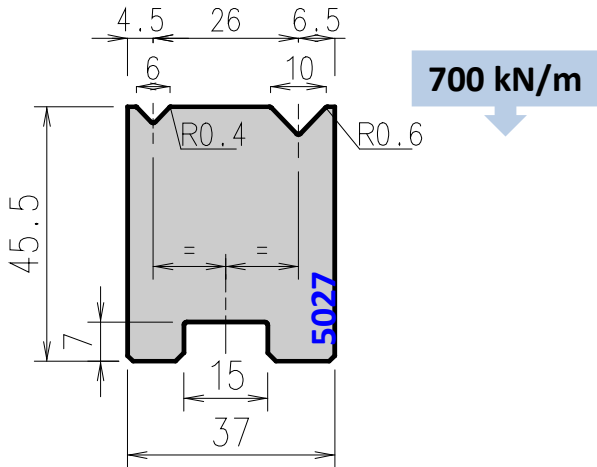

Die 502704 replaces old die 50296

Tool angle	Length mm	Item No.	Weight Kg
88°	835	ED 5027041	10,2
	415	ED 5027042	5,1
	800 sect.	ED 5027043	9,8