

AFH Standard Die 0703 (V 6)

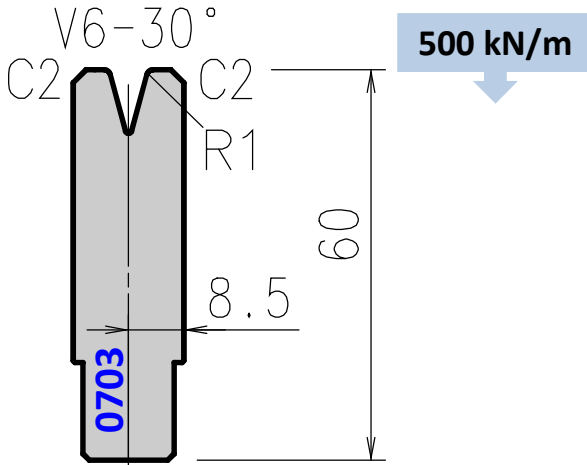

Die 0703 replaces old dies 14006 and A7003

Tool angle	Length mm	Item No.	Weight Kg
30°	835	ED0703101	6,0
	415	ED0703102	3,0
	800 sect.	ED0703103	5,7