

AFH Standard Die 0743 (V 12)

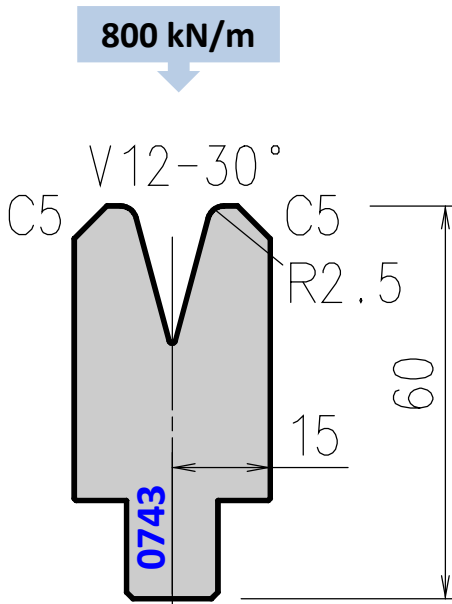

Die 0743 replaces old dies 14200 and A7403

Tool angle	Length mm	Item No.	Weight Kg
30°	835	ED0743251	9,1
	415	ED0743252	4,5
	800 sect.	ED0743253	8,7