

Standard Die 0793 (V 20)

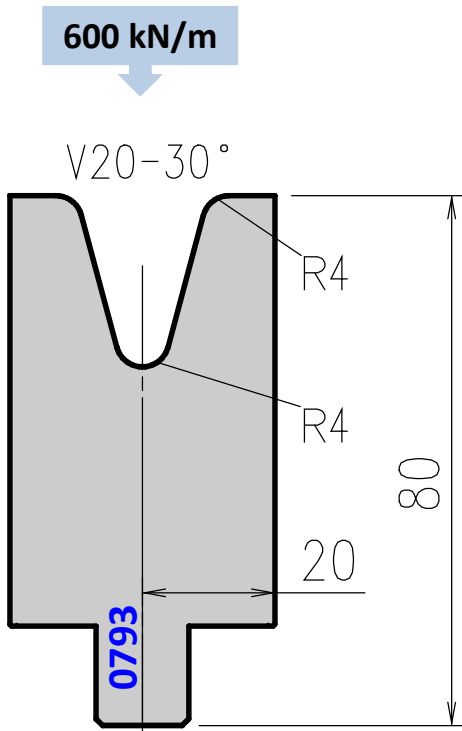

Die 0793 replaces old die 14300

Tool angle	Length mm	Item No.	Weight Kg
30°	835	ED0793401	16,4
	415	ED0793402	8,2
	800 sect.	ED0793403	15,7