

AFH Die 0706 (V 6)

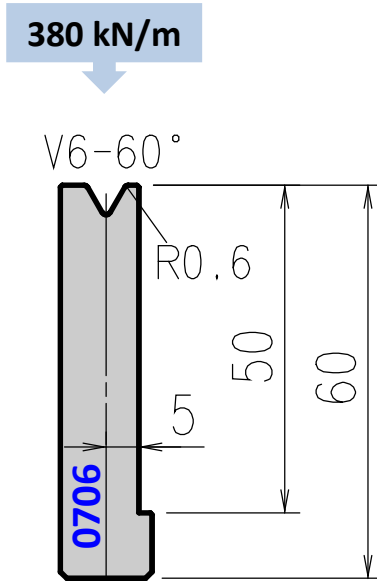

Die 0706 replaces old die 1700

Tool angle	Length mm	Item No.	Weight Kg
60°	835	ED0706061	4,7
	415	ED0706062	2,4
	800 sect.	ED0706063	4,5