

AFH Die 0746 (V 12)

550 kN/m

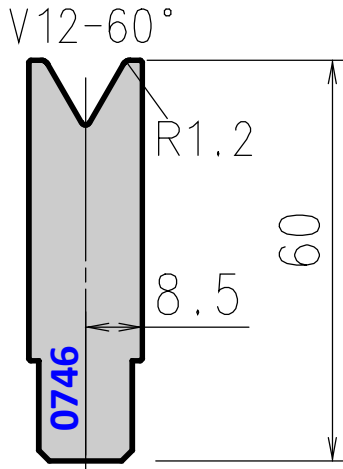

Die 0746 replaces old die 17400

Tool angle	Length mm	Item No.	Weight Kg
60°	835	ED0746121	5,9
	415	ED0746122	3,0
	800 sect.	ED0746123	5,7