

AFH Die 0826 (V 25)

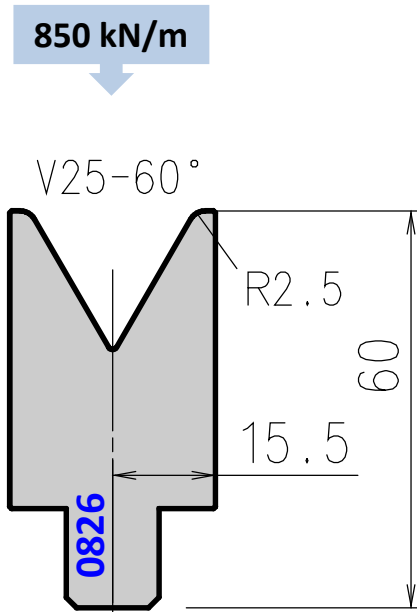

Die 0826 replaces old die 18200

Tool angle	Length mm	Item No.	Weight Kg
60°	835	ED0826251	8,7
	415	ED0826252	4,3
	800 sect.	ED0826253	8,3