

AFH Standard Die 078 (V 18)

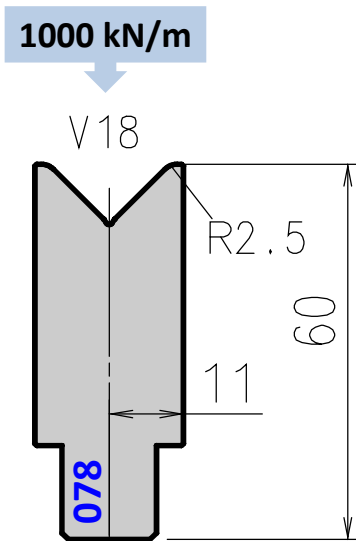

Die 078 replaces old dies 078 and A780

Tool angle	Length mm	Item No.	Weight Kg
86°	835	ED0788251	7,3
	415	ED0788252	3,6
	800 sect.	ED0788253	7,0
88°	835	ED0787251	7,3
	415	ED0787252	3,6
	800 sect.	ED0787253	7,0