

AFH Standard Die 082 (V 25)

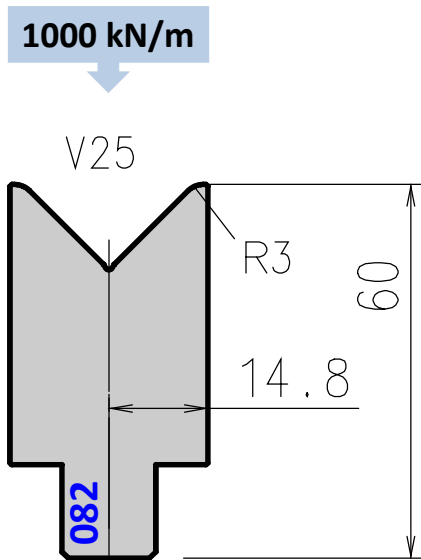

Die 082 replaces old dies 082 and A820

Tool angle	Length mm	Item No.	Weight Kg
86°	835	ED0828301	9,0
	415	ED0828302	4,5
	800 sect.	ED0828303	8,6
88°	835	ED0827301	9,0
	415	ED0827302	4,5
	800 sect.	ED0827303	8,6