

AFH Standard Die 0884 (V 40)

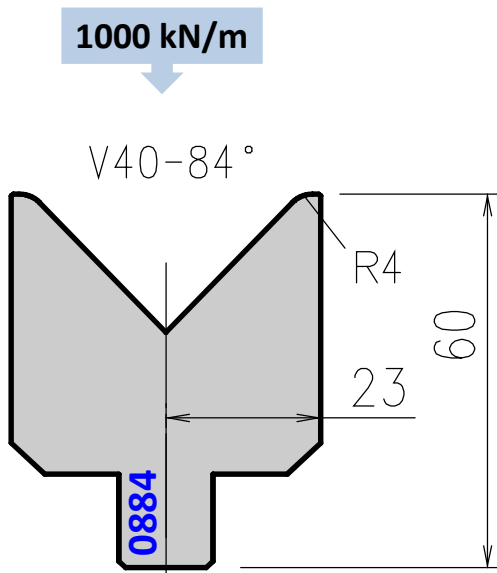

Die 0884 replaces old die A880

Tool angle	Length mm	Item No.	Weight Kg
84°	835	ED0884401	11,8
	415	ED0884402	5,9
	800 sect.	ED0884403	11,3