

Staged* Die 1708 (V 6)

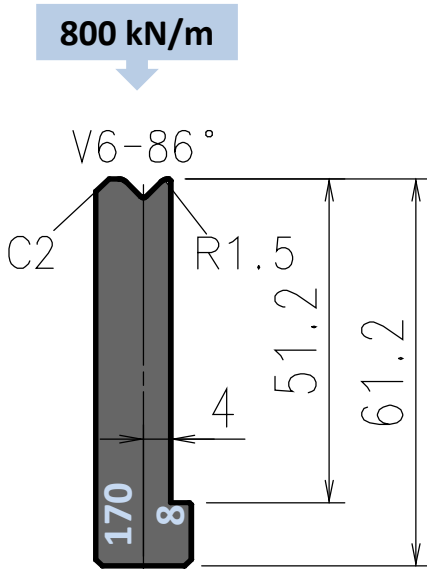

Die 1708 replaces old die S708

Tool angle	Length mm	Item No.	Weight Kg
86° staged	835	ED1708151	4,6
	415	ED1708152	2,3
	800 sect.	ED1708153	4,4