

Staged* Die 1713 (V 8)

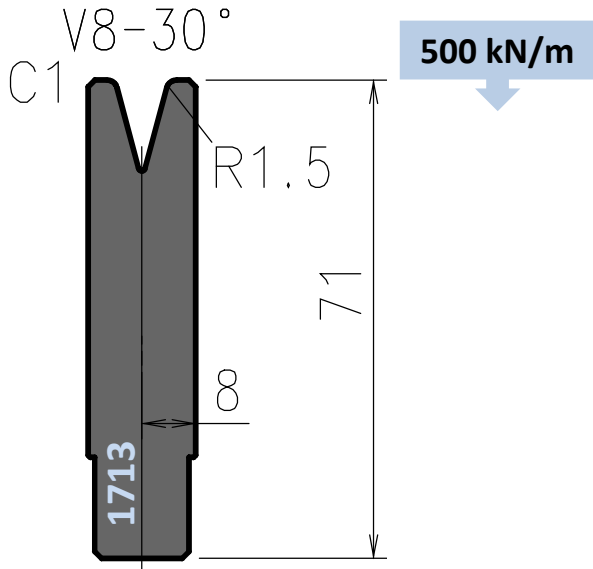

Die 1713 replaces old die S7130

Tool angle	Length mm	Item No.	Weight Kg
30° staged	835	ED1713151	6,8
	415	ED1713152	3,4
	800 sect.	ED1713153	6,5