

Staged* Die 1718 (V 8)

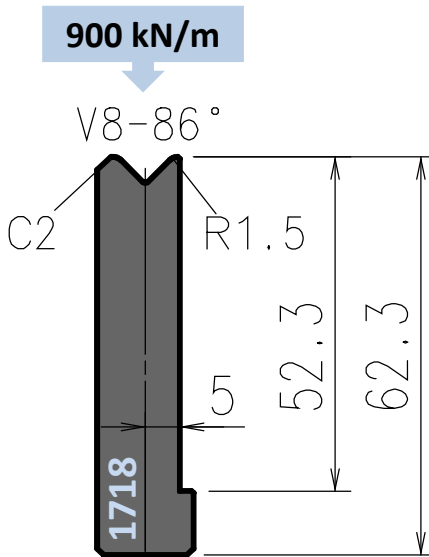

Die 1718 replaces old die S718

Tool angle	Length mm	Item No.	Weight Kg
86° staged	835	ED1718151	4,9
	415	ED1718152	2,5
	800 sect.	ED1718153	4,7