

Staged* Die 1828 (V 25)

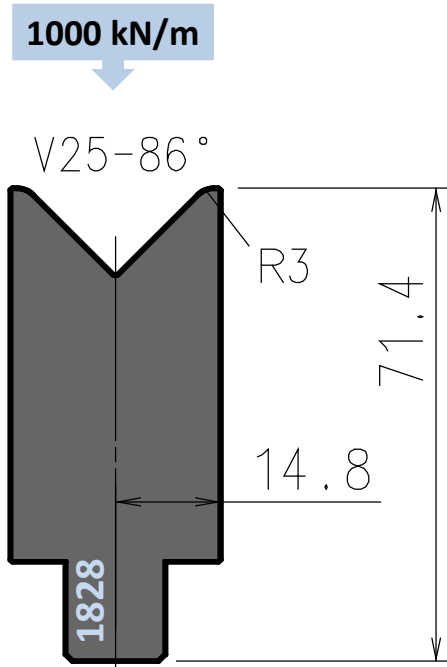

Die 1828 replaces old die S828

Tool angle	Length mm	Item No.	Weight Kg
86° staged	835	ED1828301	10,6
	415	ED1828302	5,3
	800 sect.	ED1828303	10,2