

Staged* Die 1848 (V 4)

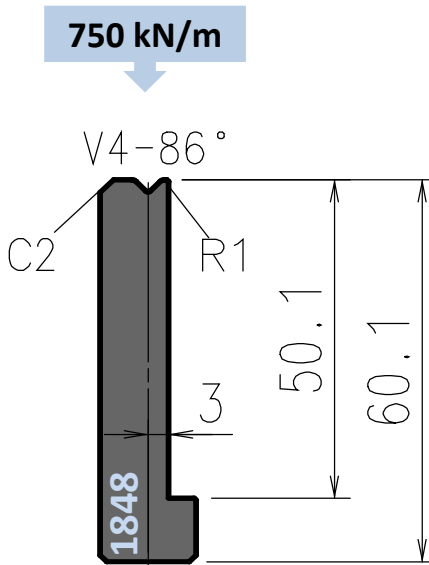

Die 1848 replaces old die S848

Tool angle	Length mm	Item No.	Weight Kg
86° staged	835	ED1848101	4,3
	415	ED1848102	2,2
	800 sect.	ED1848103	4,1